



**CONSCIOUS TECHNICAL PROJECTS  
& MANAGEMENT SERVICES PVT LTD**

[www.ctpms.co.in](http://www.ctpms.co.in)

we are a team of experienced professionals offering high-quality **Design, Engineering, and Inspection** services.

We serve a broad spectrum of industries, including:

- ◆ Chemicals
- ◆ Pharmaceuticals
- ◆ Oil & Gas
- ◆ Petrochemicals
- ◆ Wastewater Treatment
- ◆ Food Processing

Our capabilities core engineering to include:

- ✓ **GeM (Government eMarketplace) Tender Participation**
- ✓ **Chartered Engineering Certification**
- ✓ **Plant & Machinery Valuation Services (India & Abroad)**

We are committed to delivering **precise, compliant, and client-focused** solutions with a strong emphasis on quality and reliability.

- **2D-3D Modelling & Drafting**
- **Skid/Stack/Derrick Design-analysis-Fabrication drawing**
- **Thermal analysis-Heat Exchangers & other**
- **Structural Analysis**
- **Piping Design-analysis**
- **Computational Fluid Dynamics (CFD)**
- **Finite Element Analysis (FEA)**
- **Inspection & NDT**

**We Deliver following without Compromising  
Quality and with Competitive cost**

## **Engineering Services**

### **Vessel and Heat Exchanger:**

- Pressure Vessel and Heat Exchanger calculations using PVElite, Codecalc, Compress, NozzlePro, ANSYS and in-house developed Calculation Sheet
- Rectangular vessel calculations
- Local stress calculation per WRC bulletin 537,107&297
- Shipping and Lifting Calculations
- Calculation for Vessel Internals
- Platform structure design & platform clip design
- Tank Design as per API 650, API 620 and Silo Design
- Air Cooler Design as per API661
- Thermal and Hydraulic design for heat exchanger using HTRI

## **Piping**

- Piping Stress Analysis for piping related to Steam service, Oil & Gas, Petrochemical, Chemical Plant as per ASME B31.3 and ASME B31.1 using CAESAR tool
- Stress analysis of underground piping
- Modelling of piping using softwares like CADWorx
- Piping material specification
- Isogen with BOM, spool drawing preparation
- The piping stress analysis and detailing includes Equipment modeling, nozzle check, stress analysis, pipe support location, clash check, isometric.

## **Structure & Stack**

- Skid structural layout engineering and calculations
- Steel tower/ Derrick structure & connection design calcs
- Stack calculations
- Piperack structural calculations
- Spreader beam and shipping frame calculations

## Finite Element Analysis

- FEAs per ASME Sec. VIII. Div. 2 / API 579 – ASME FFS1
- Type of Analysis includes : Thermal – steady state & transient, Structural – steady state & transient, Linear Elastic, Nonlinear– Plastic, Coupled analysis, Fatigue, Creep
- The FEA includes Nozzle analysis, entire equipment analysis, hotbox analysis, lifting analysis, fatigue analysis, creep analysis etc.
- FEA for the abnormalities as vessel damage / denting and corresponding repair work, Vessel ovality, skirt offsets due to ovality, baffle analysis to predict the failure of baffle etc.
- Thermal + Mechanical analysis of Heat exchanger
- FEA for expansion bellow
- Analysis of any miscellaneous component
- Validation of third party, third software

## **TEKLA STRUCTURES 3D MODELING & EDITING SERVICE**

Tekla Structures is a powerful 3D modeling and information management software for the construction industry. It can be used to model all types of structures, from simple to complex. Our team of experienced Tekla Structures engineers can provide you with a wide range of modeling and editing services, including:

- **3D modeling** of all types of structures, Like Offshore & Onshore, Architectural, etc...
- **Editing** of existing Tekla Structures models
- **Clash detection** and resolution
- **Material takeoff**
- **Shop drawing & Erection drawing** production
- **IFC export** for interoperability with other software
- **Customize reports** as per client requirement
- **DSTV & dxf** Etraction from Tekla model

### **Benefits of using our Tekla Structures modeling and editing services**

- **Improved accuracy** and efficiency of your projects
- **Reduced costs** by eliminating errors and rework
- **Improved communication** and collaboration between project stakeholders

## Thermal design and Computational Fluid Dynamics Analysis

- Heat Transfer Analysis of all components
- Flow through Pipes, Valves & Fittings
- Pressure Loss, Velocity, Temperature prediction
- Combustion & Multiphase flow CFD analysis
- Flow through Turbomachines
- Mixing analysis
- Reactive and non-reactive flow in chemical reactors and boilers
- Aerodynamic simulation
- Thermal analysis of Battery system, Solar, Heat Exchangers, Boiler etc. .

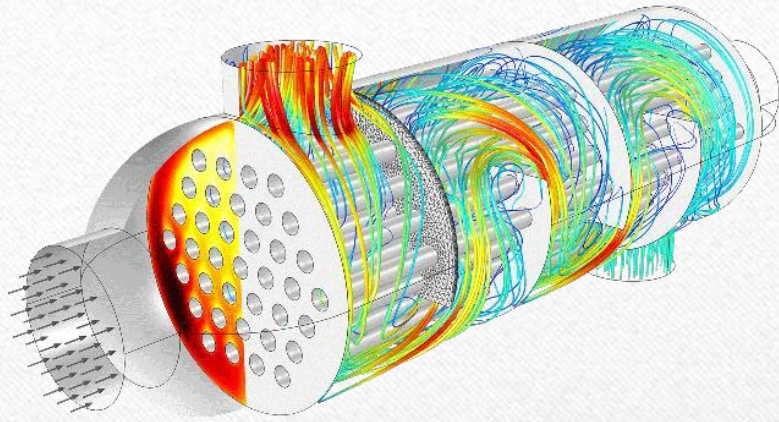

**Heat Exchangers**

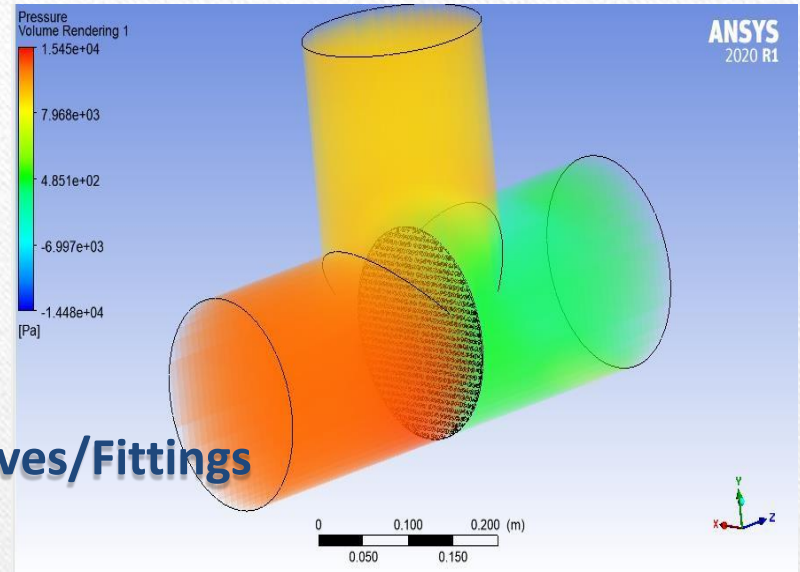

**Valves/Fittings**

**Cold domain**

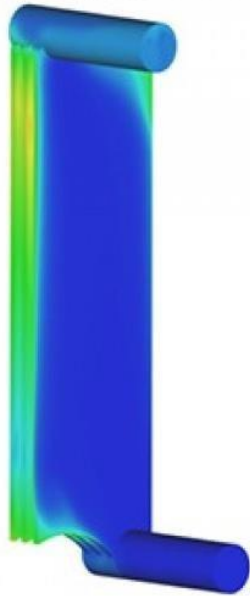

**Hot domain**

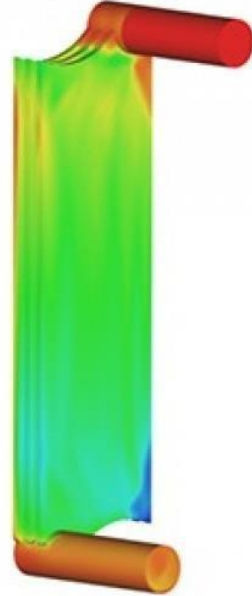

**Turbomachines**

Total Pressure  
(Contour 2)

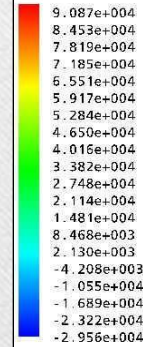

[Pa]

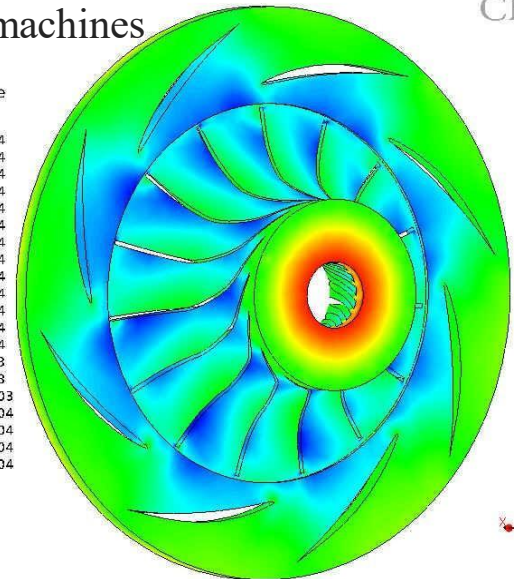

# Combustion Simulation

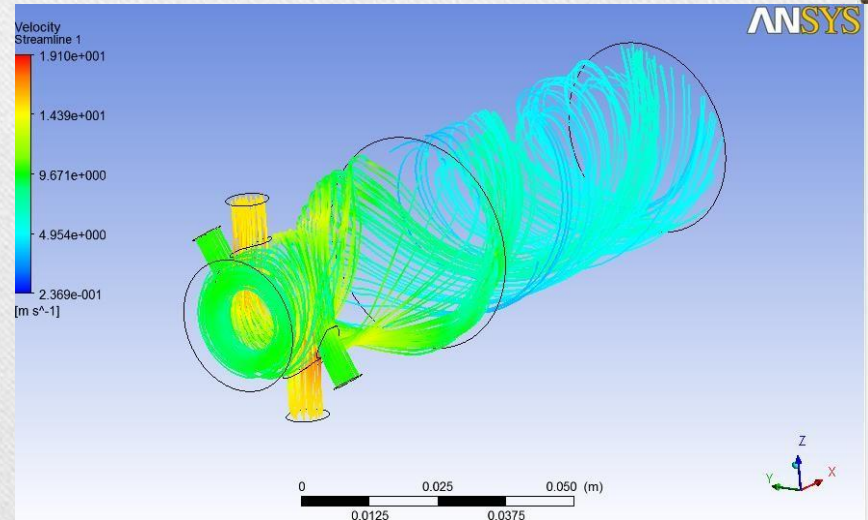
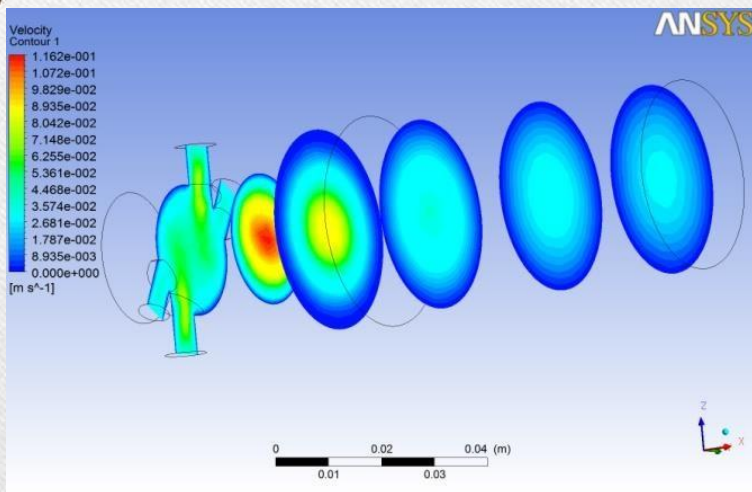
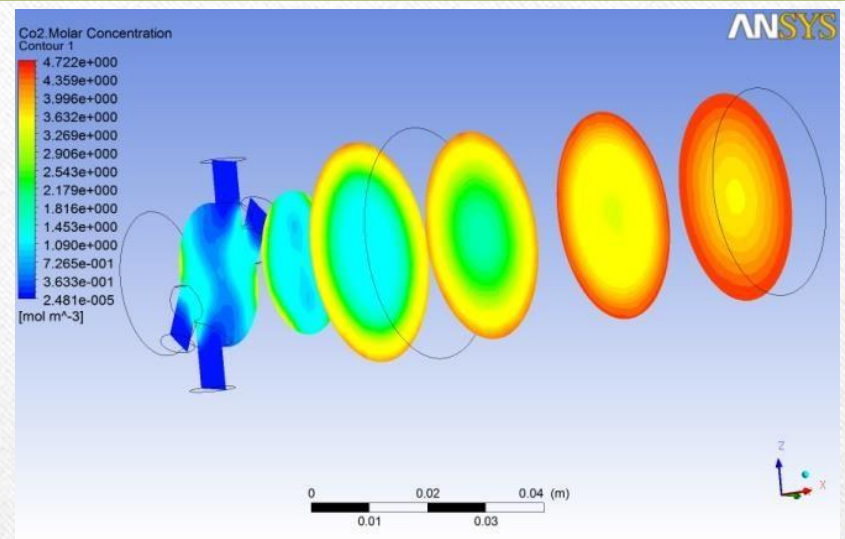
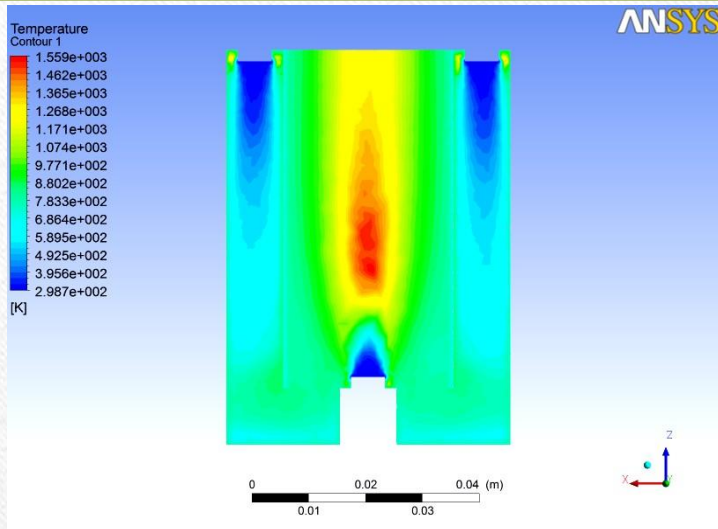

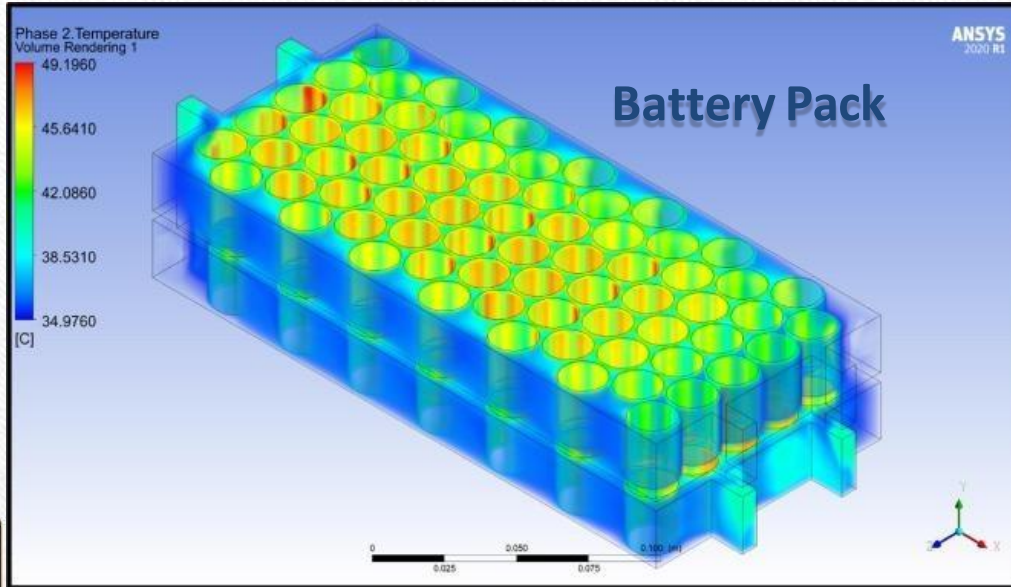

## Air Heater/Reactor

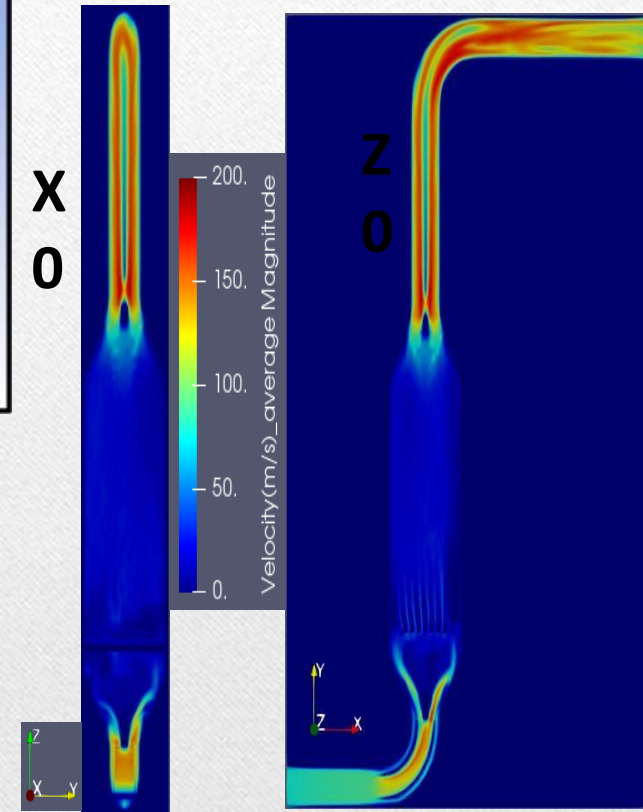

## Mixing efficiency

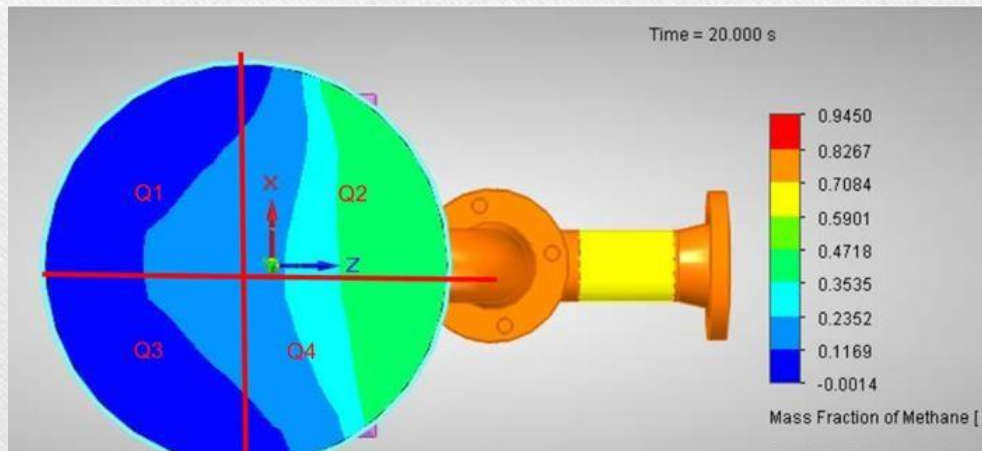

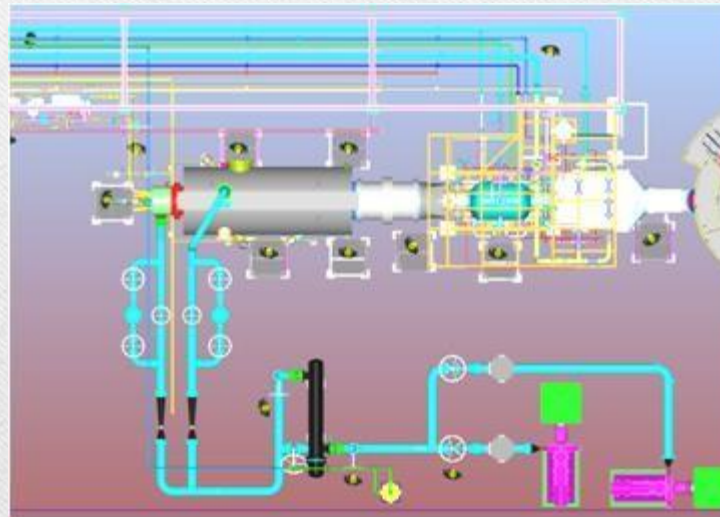
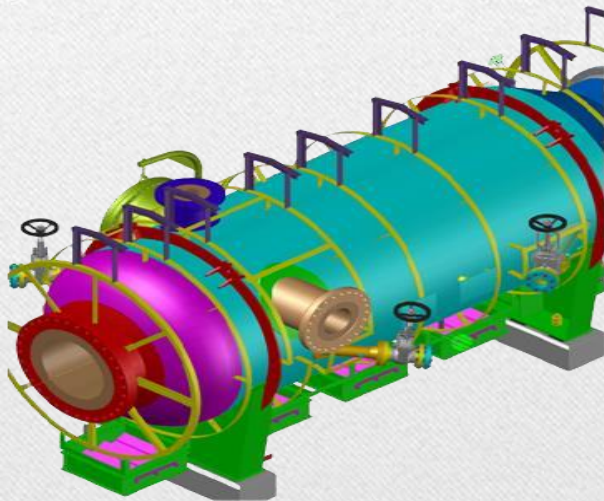
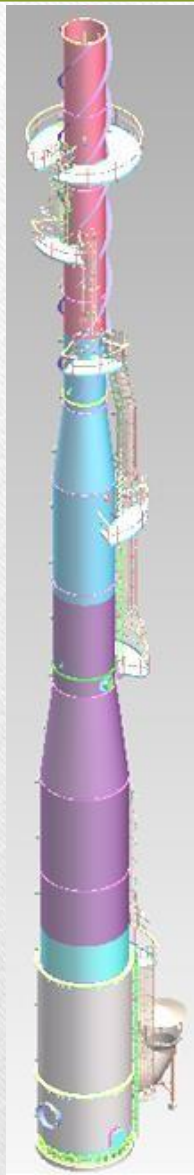
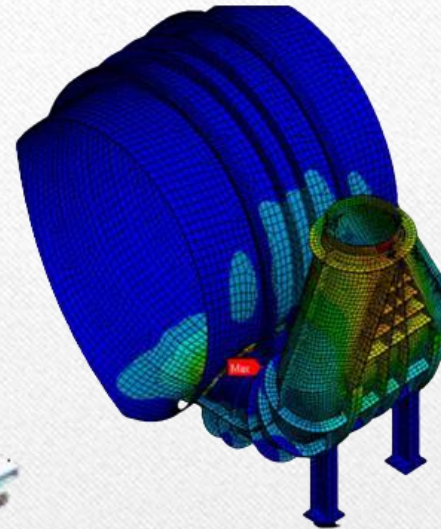
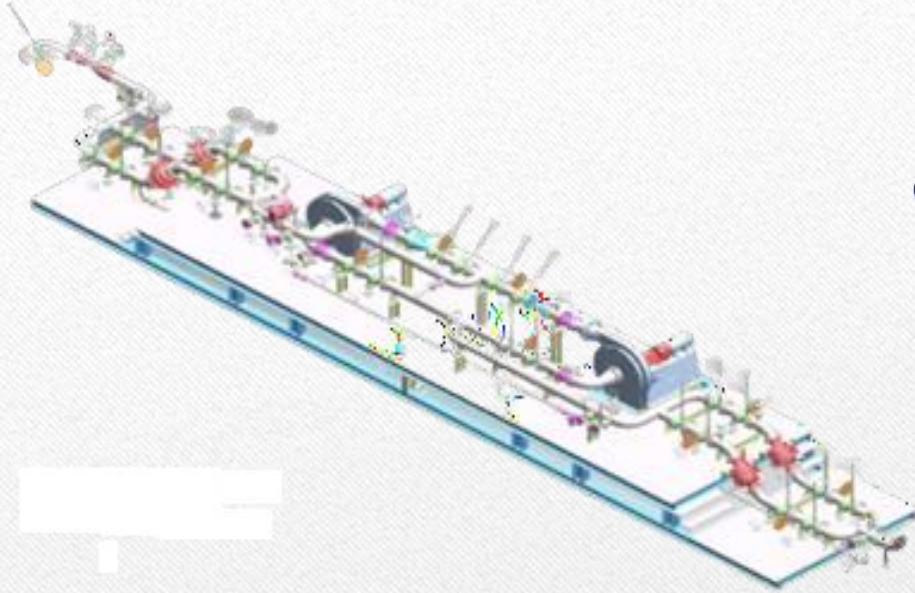

## 3D Modelling and Drafting Services

### Vessel and Heat Exchanger

- General Arrangement and Detail Fabrication drawings
- Shipping/Transportation drawings
- Erection drawings

### Piping

- Modelling of piping using softwares like CADWorx
- Piping material specification
- Isogen with BOM, spool drawing preparation
- The piping stress analysis and detailing includes Equipment modeling, nozzle check, stress analysis, pipe support location, clash check, isometric.

### Structure

- General Arrangement and Detail Fabrication drawings
- Connection detailing

***Layout engineering and weight during pre-order stage***

# NDT Testing / Inspection Services / Consultant



**Ultrasonic Testing (UT)**



**Magnetic Particle Testing (MT)**



**Radiography Testing (RT)**



**Dye Penetrant Test (DPT)**



**(Material Characterization)**

## Our Clients

### **ZEECO India Pvt Ltd, India**

Zeeco India offers comprehensive combustion products, design and engineering capabilities, and aftermarket services to its customers in the refining, production, LNG, petrochemical, power, pharmaceutical, and biogas industries.

### **APPYlife, Milan, Italy**

Appylife is into developing small, medium and large scale engineering projects worldwide from USA to Asia Pacific, from Middle East to Europe.

### **Aereon, Italy**

Aereon offer the broadest product line of air-emission control equipment, including custom and standard flare systems, enclosed combustion systems, flare gas recovery and vapor recovery units.



APPYLIFE



## Our Clients

### Zetwerk India Pvt Ltd

**Zetwerk** is a partner to leading players in precision parts, capital goods and consumer goods categories, offering a full spectrum of manufacturing services – from custom-made components to mass production, from quality certification to inventory and supply chain management.

### Technimont, Italy

**Tecnimont** is an **international leader** in the field of plant engineering, rooted in the pioneering experience of Italian industrial technology shaping the new frontiers of **Engineering Innovation**.

### CECO,

CECO Environmental is a leading environmentally focused, diversified industrial company, provide custom engineered solutions for applications including oil and gas, power generation, water and wastewater, battery production, poly silicon fabrication, chemical and petrochemical processing.



## Our Clients

### Treadwell Group Pty Ltd

Treadwell Group leads the industry with its cutting-edge FRP (Fibreglass Reinforced Plastic) solutions and anti-slip materials, revolutionizing safety and performance across various sectors.

### Larsen & Toubro LTD

L&T's capability spectrum covers coal, gas, nuclear and renewable power projects. Our expertise encompasses every aspect of design, engineering, manufacture, construction and project management.

**TREADWELL™**



# Our Team

**Conscious Technical Projects & Management Services  
PVT LTD.**

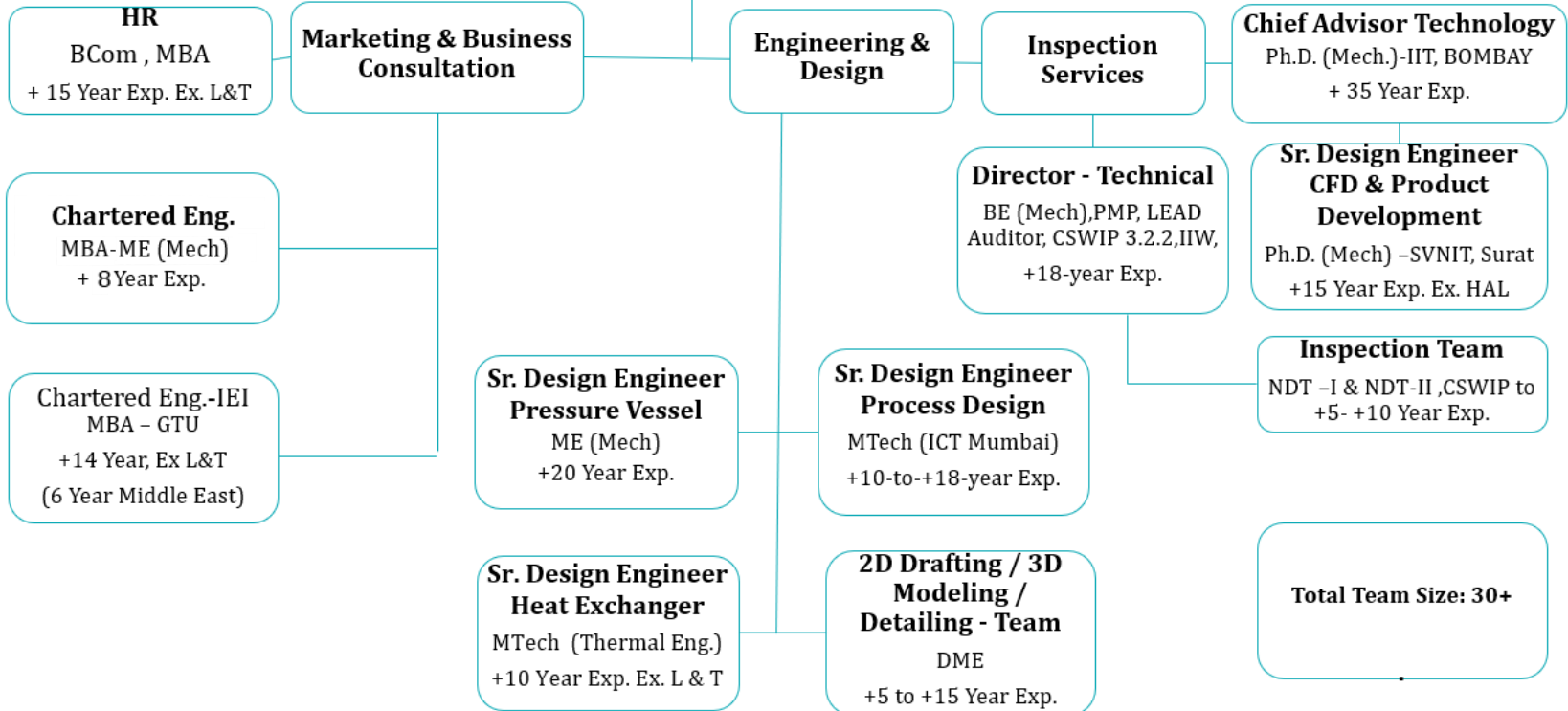

**Firm Name**

**Conscious Technical Projects & Management  
Services Pvt Ltd**

**Address**

Reg. Office BFF/7, ABC building Marketyard  
Vyara, Dist: Tapi- Surat Gujarat- India  
Pin 394650

**Contact no.**

Branch Office : M-71, Raj mahal mall , Sitanagar  
chokadi , punagam Surat Gujarat India  
+91-9586199130

**Email:**

[marketing@ctpms.co.in](mailto:marketing@ctpms.co.in)  
[www.ctpms.co.in](http://www.ctpms.co.in)

**GST**

24AAMCC7418B1ZW

**Bank Detail:**

STATE BANK OF INDIA  
A/C : 44179886348  
RTGS/NEFT IFS Code : SBIN0018547  
Jilla Seva Sadan Campus, Panwadi,  
Vyara, Dist Tapi, Gujarat- 394650

Thank you!